

# Close to you.

MANUFACTURER **SINCE 1921**



**1921**

ORTHO  **master**

HELMUT ZEPF

ORTHO  master

*The better grade of dental instruments since 1921*

# Goldener Meisterbrief

Helmut Zepf

Chirurgiemechanikermeister

FÜR 40 JAHRE MEISTER DES DEUTSCHEN HANDWERKS  
VERLIEHEN VON DER HANDWERKSKAMMER KONSTANZ

  
PRÄSIDENT

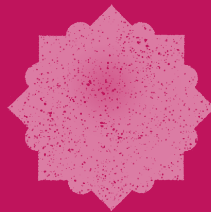

  
SYNDIKUS

KONSTANZ, DEN

29. MAERZ 1987

<b>Aligner Pliers</b>	04
<b>Wire bending pliers</b>	05
<b>Hammerhead-Pliers</b>	04
<b>Distal cutter</b>	05
<b>Wire bending pliers</b>	06
<b>Distal cutter</b>	07
<b>Ligatur cutter</b>	08
<b>Wire cutting pliers</b>	09
<b>Ligature pliers</b>	10
<b>Bracket &amp; ligature removal pliers</b>	11
<b>Debonding &amp; removal pliers</b>	12
<b>Bandinstruments</b>	13
<b>Bracket positioners</b>	14
<b>Bracket forceps</b>	15
<b>Mosquito for ligatures</b>	16
<b>Mathieu for ligatures</b>	17
<b>Caliper</b>	18
<b>Photo and cheek retractors</b>	19
<b>Ligature instruments</b>	20
<b>Brushes / Medical whiteoil</b>	21
<b>Washtrays</b>	22



**ZEPF** Aligner pliers**A-Punch Plier****33.720.42**

The A-Punch Pliers are there applied, where plastic has to be removed from the bar. For example to create space for accessory parts like pasting knobs or attachments.

**Horizontal Plier****33.720.44**

The Horizontal Pliers are for installation of horizontal deformations in the plastic bar, with which you can strengthen an appropriate root torque. These deformations can also be used selectively in small steps, to improve the retention of the plastic bar.

**Vertical Plier****33.720.43**

The purpose of the Vertical Pliers is the fixation of defined vertical deformation in the plastic bar, with which you can create pressure on the tooth which has to be rotated mesially or distally by oral or vestibular.

## Wire bending pliers

Made from forged high-carbon steel,  
Wire 0.56 x 0.70 mm / 22 x 28



**Angle Arch Forming Plier**

**33.710.31**

Made from forged high-carbon steel,  
Wire max. thickness 0.70 mm, hard



**Angle Bird Beak Type  
Wire Bending Plier**

**33.711.30**



3 steps with replaceable insert  
Tungsten carbide sprayed on



**Tweed Loop Plier**

**33.712.41**

Wire bending pliers

**Wire bending pliers Aderer NITI**

Three-finger pliers 12 cm,  
max. thickness 0.5 mm / 20"

**33.713.16**



**Hammerhead - Plier Chinch back**

For bending NITI wires  
Wire max. thickness 0.3 - 0.7mm

**33.720.50**



**Lingual arch forming plier**

**33.730.20**



## Distal cutter



### Distal cutter mini

High carbon steel inserts  
Wire max. thickness 0.56 x 0.70 mm  
Cut and safety hold

**33.750.01F**

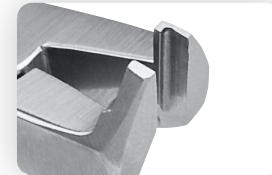

**Distal cutter** Length 14 cm  
High carbon steel inserts  
Wire max. thickness 0.56 x 0.70 mm / 22 x 28  
Cut and safety hold

**33.750.02**

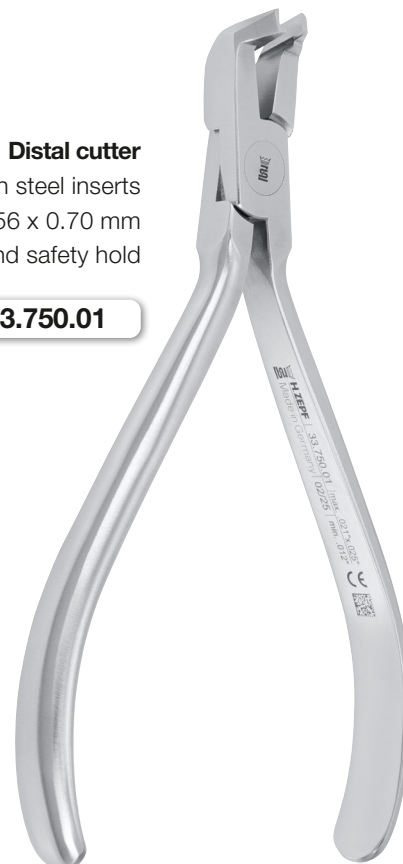

**Distal cutter**  
High carbon steel inserts  
Wire max. thickness 0.56 x 0.70 mm  
Cut and safety hold

**33.750.01**



### Ligature cutters

**Ligature cutter** Lenght 11 cm  
High carbon steel inserts  
Wire max. thickness 0.4 mm/0.16", soft

**33.760.02**

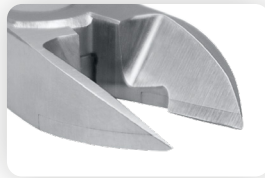

**Ligature cutter** Lenght 12 cm  
High carbon steel inserts  
Wire max. thickness 0.5 mm, soft

**33.760.21**



**Ligature cutter** Lenght 11.5 cm  
High carbon steel inserts  
Wire max. thickness 0.4 mm/0.16", soft

**33.760.03**



Wire-cutting pliers



**Wire-cutting pliers** Length 12 cm  
High carbon steel inserts  
Wire max. thickness 0.7 mm, hard

**33.760.11**



**Ligature cutter 45°** Length 12 cm  
High carbon steel inserts  
Wire max. thickness 0,4 mm, soft

**33.760.20**



## Ligature pliers



**Ligature pliers Weingart, Standard**  
Made from forged high-carbon steel

33.740.11



**Ligature pliers Weingart, mini**  
Made from forged high-carbon steel,  
Wire max. thickness 0.5 mm, hard

33.740.12

## Bracket & ligature removal pliers

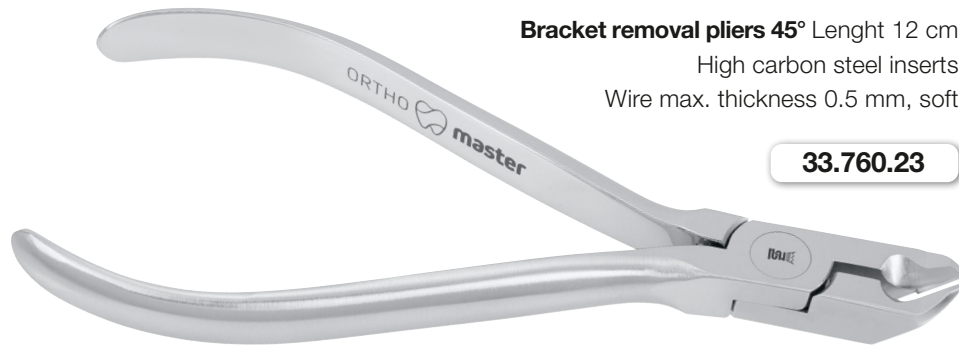

**Bracket removal pliers 45°** Lenght 12 cm  
High carbon steel inserts  
Wire max. thickness 0.5 mm, soft

**33.760.23**



**Bracket removal pliers**  
short jaw branches  
with plastic insert

**33.770.25**

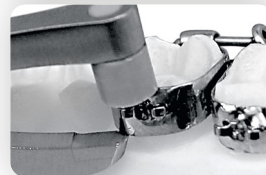

**Oliver Band Removing Plier**  
Made from forged  
high-carbon steel  
with plastic insert

**33.770.21**



**Plastic inserts**  
PU: 10 pcs.

**33.770.22**



Debonding & removal pliers

**Debonding & removal pliers**

2 mm, straight, made of forged high-carbon steel

**33.770.40**



**Debonding & removal pliers**  
angled, with hard steel insert

**33.770.52**

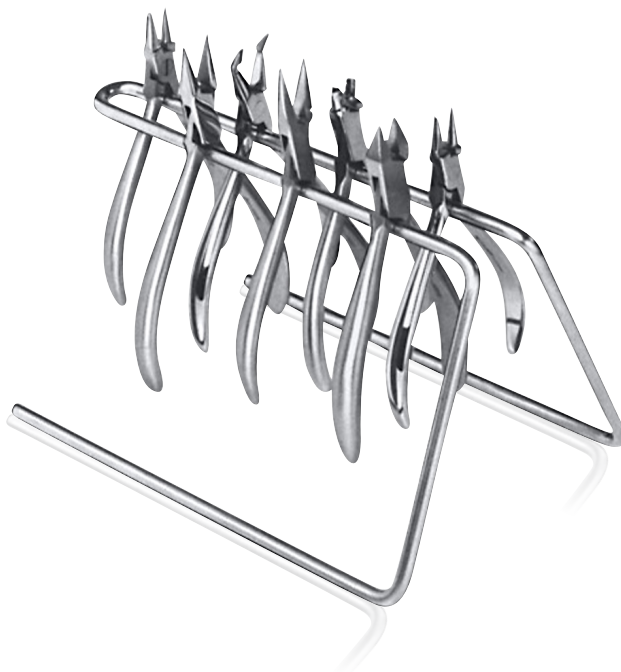

**Pliers stand**

Metal, Pick-up length 20 cm

**31.995.00**



Band Instruments



**Band pusher Mershon**

**19.261.00AS**

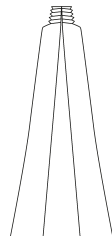

**Force module separator**  
15 cm

**33.770.14**



**Molar band seater** Length 14,7 cm,  
with serrated triangular carbide tip

**19.263.50**



Band Instruments / Bracket Positioner



**Probe Fig. 17**

round checkered handle, stainless steel, single-ended

**24.102.17**



**Probe Fig. 17**

Octagonal handle, stainless steel, single-ended

**24.101.17**



**Bracket Positionierer**

13 cm, 018 Slot, stainless steel, hardened

**19.260.00AS**



**Bracket Positionierer**

13 cm, 022 Slot, stainless steel, hardened

**19.260.10AS**



Bracket Forceps



**Direct Bond Bracket Holder**  
for placing and angulating brackets

**31.299.90**



**Direct Bond Bracket Holder**  
for placing and angulating brackets

**31.299.21**



**Direct Bond Bracket Holder**  
for placing and angulating brackets

**31.299.01**



**Direct Bond Bracket Holder**  
for placing and angulating brackets

**31.299.99**



## Mosquito for Ligatures



**Halstead-Mosquito**  
grooved, curved, 12.5 cm

**23.055.12KFO**



**Halstead-Mosquito**  
grooved, straight, 12.5 cm

**23.054.12KFO**



**Beebee, Crown scissors**  
pointed, straight, 10 cm

**46.674.10**

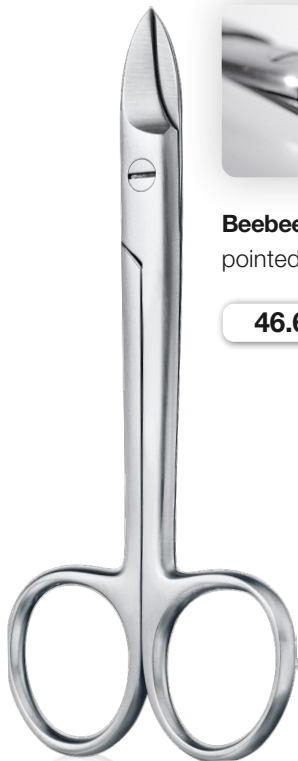

**Beebee, Crown scissors**  
pointed, curved, 10 cm

**46.675.10**

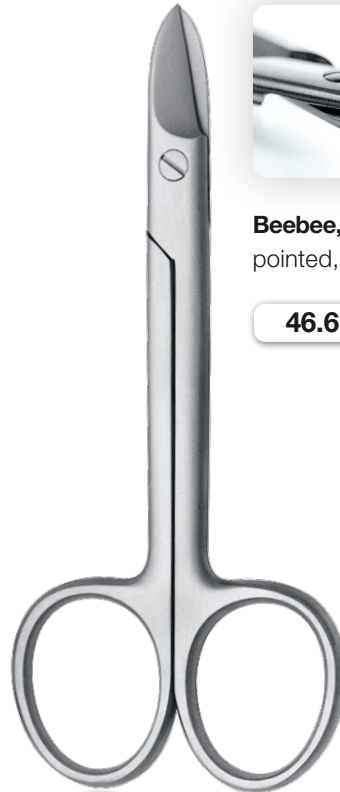

Mathieu for Ligatures



**Mathieu Ligature Instrument**

17 cm, 2.0 mm,  
Inner lock,  
slim design

**41.262.17KFO**



**Mathieu Ligature Instrument**

17 cm, 2.8 mm,  
Inner lock,  
wider design

**41.264.17KFO**



**Mathieu Ligature Instrument**

14 cm, 2.0 mm,  
Inner lock, slim design

**41.262.14KFO**



**Mathieu Ligature Instrument**

14 cm, 2.8 mm,  
Inner lock, wider design

**41.264.14KFO**



### Mathieu for Ligatures



**Mathieu Ligature Instrument**  
very delicate design

**41.260.14KFO**



**Orthodontic Caliper „Zürcher-Modell“**  
Length 128 mm  
for measuring on the model

**31.695.00**





### ZEPF Photography and Cheek Retractor, in the Onyx Version or stainless steel

**HELMUT ZEPF** Cheek Retractors are frequently used in intraoral photography, in extensive cheek retraction, in dental diagnostics and in surgery.

Conventional retractors are also available in plastic material. However, depending on the used plastic, these are not always entirely harmless when being prepared in the hygiene chain. Our retractors are made of stainless medical steel and fulfill all the requirements of the RKI guidelines.

The ergonomic design of the retractors guarantees an optimal handling and is well accepted by patients.



37.457.00TI

1/1, Scale 1:1

37.457.00

1/1, scale 1:2

37.457.01TI

37.457.01

1/2 left, scale 1:2

37.457.02TI

37.457.02

1/2 right, scale 1:2



## Ligature instruments



Scaler/belt pusher grooved

27.262.01



Ligature adapter, double-ended

27.600.61



Ligature adapter, double-ended  
Slot width 0.7 mm ± 0.1 mm

27.600.61F

Brushes / Medical whiteoil



**Oil-Pen**  
18 ml

24.950.12



**Paraffinum Perliquidum**

50 ml, Medical Whiteoil for maintenance of instrument hinges and for use as sharpening oil. Physically harmless acc. to DAB 10.

24.950.10



**Brush**

double-sided, sterilizable,  
PU: 3 pcs.

85.903.01



**Brush for aspirator**

Ø 1.5 mm

85.903.03



**Brush for aspirator**

Ø 3 mm and Ø 5 mm

85.903.04



**ZEPF Washtrays****Washtray 1/3**

for 5 Instruments with 2 Instrument supports  
and 1 hold-down device, 178 x 90 x 24 mm

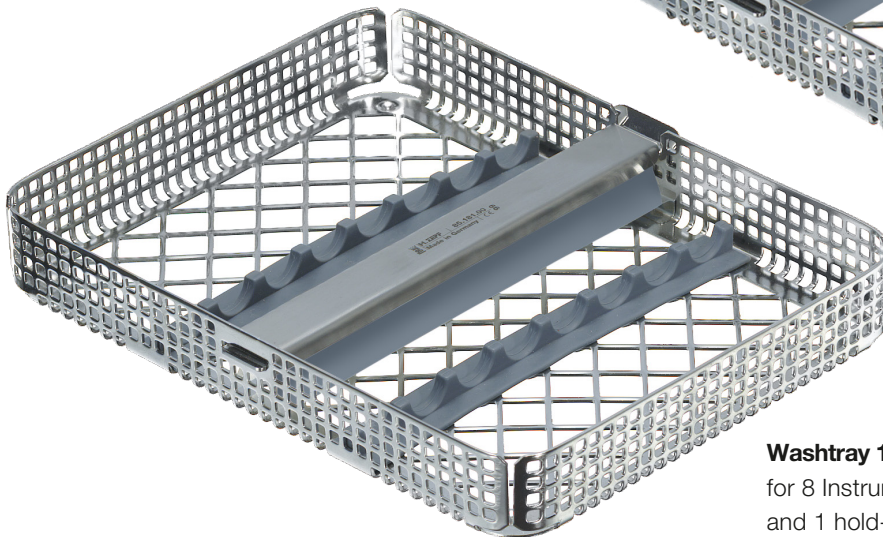
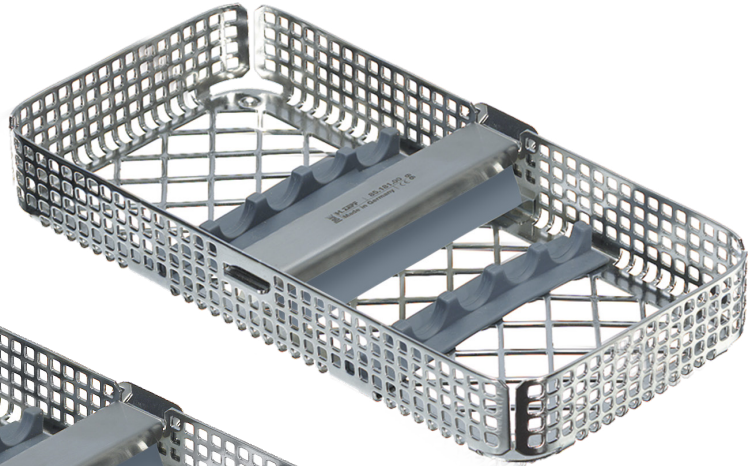
**85.182.00****Washtray 1/2**

for 8 Instruments with 2 Instrument supports  
and 1 hold-down device, 178 x 140 x 24 mm

**85.181.00****Washtray 1/1**

for 16 Instruments with 2 Instrument supports  
and 1 hold-down device, 275 x 178 x 24 mm

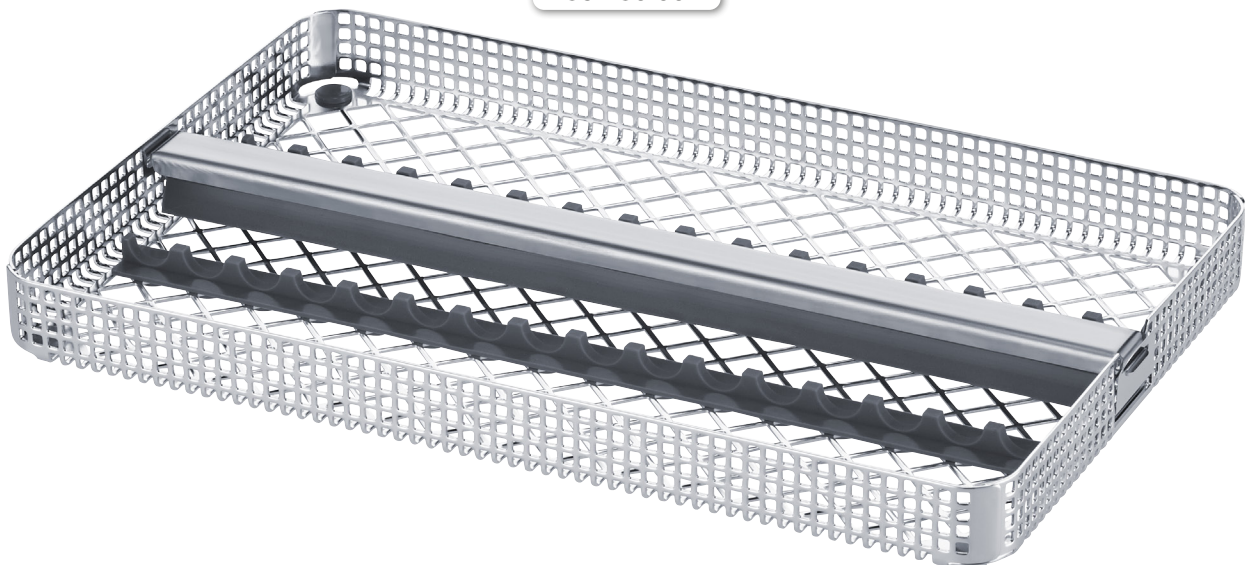
**85.180.00**

## Numerical Index

**CE** All medical devices indicated here bear the CE mark.  
For products higher than Class I, the identification number of the notified body is also shown.

<b>19.260.00AS</b>	14
<b>19.260.10AS</b>	14
<b>19.261.00AS</b>	13
<b>19.263.50</b>	13
<b>23.054.12KFO</b>	16
<b>23.055.12KFO</b>	16
<b>24.101.17</b>	14
<b>24.102.17</b>	14
<b>24.950.10</b>	21
<b>24.950.12</b>	21
<b>27.262.01</b>	20
<b>27.600.61</b>	20
<b>27.600.61F</b>	20
<b>31.299.01</b>	15
<b>31.299.21</b>	15
<b>31.299.90</b>	15

<b>31.299.99</b>	15
<b>31.695.00</b>	18
<b>31.995.00</b>	12
<b>33.60.20</b>	9
<b>33.710.31</b>	5
<b>33.711.30</b>	5
<b>33.712.41</b>	5
<b>33.713.16</b>	6
<b>33.720.42</b>	4
<b>33.720.43</b>	4
<b>33.720.44</b>	4
<b>33.720.50</b>	6
<b>33.730.20</b>	6
<b>33.740.11</b>	10
<b>33.740.12</b>	10
<b>33.750.01</b>	7

<b>33.750.01F</b>	7
<b>33.750.02</b>	7
<b>33.760.02</b>	8
<b>33.760.03</b>	8
<b>33.760.11</b>	9
<b>33.760.21</b>	8
<b>33.760.23</b>	11
<b>33.770.14</b>	13
<b>33.770.21</b>	11
<b>33.770.22</b>	11
<b>33.770.25</b>	11
<b>33.770.40</b>	12
<b>33.770.52</b>	12
<b>37.457.00</b>	19
<b>37.457.00TI</b>	19
<b>37.457.01</b>	19

<b>37.457.01TI</b>	19
<b>37.457.02</b>	19
<b>37.457.02TI</b>	19
<b>41.260.14KFO</b>	18
<b>41.262.14KFO</b>	17
<b>41.262.17KFO</b>	17
<b>41.264.14KFO</b>	17
<b>41.264.17KFO</b>	17
<b>46.674.10</b>	16
<b>46.675.10</b>	16
<b>85.180.00</b>	22
<b>85.181.00</b>	22
<b>85.182.00</b>	22
<b>85.903.01</b>	21
<b>85.903.03</b>	21
<b>85.903.04</b>	21





**HELMUT ZEPF**

ZEPF Online Catalog



**sustainable | up-to-date | complete | contemporary | mobile | practical**

We also offer you our dental catalog in digital form.  
In this way, we protect our environment, and you can access our extensive dental program anytime and anywhere.  
Simply scan this QR code with your smartphone, or visit our media library at [www.zepf-dental.com](http://www.zepf-dental.com)!

[zepf-dental.com](http://zepf-dental.com)

**ZEPF** | *dental*  
PRODUCTS

Close **to you.**